

- L2+ switch
- Stacking support
- Multicast support (IGMP Snooping, MVR)
- Advanced security functions (L2-L4 ACL, IP Source Guard, Dynamic ARP Inspection, etc.)

New generation of access switches provides end users connection to a large-scale corporate network, small and medium business networks and to a service provider networks using 1G/10G interfaces.

The switches support physical stacking, VLANs, multicast groups and advanced security functions.



MES2324



MES2324F



MES2324FB

Technical features

	MES2324	MES2324B	MES2324F	MES2324FB	MES2326	MES2348B
Common parameters						
Packet processor	Marvell 98DX3236-A1 (AlleyCat3)				Marvell 98DX3235	Marvell 2x98DX3236-A1 (AlleyCat3)
Interfaces						
10/100/1000BASE-T (RJ-45)	24		—	24	48	
1000BASE-X/100BASE-FX (SFP)	—	—	20	—	—	
1000BASE-X (SFP)	—	—	—	2	—	
10/100/1000BASE-T/1000BASE-X/100BASE-FX Combo	—	—	4	2	—	
10GBASE-R (SFP+)/1000BASE-X (SFP)	4		4	—	4	
Console port	RS-232/RJ-45					
Performance						
Bandwidth	128 Gbps			56 Gbps	176 Gbps	
Throughput for 64 bytes	92.1 MPPS			41.4 MPPS	130.9 MPPS	
Buffer memory	12 Mbit			24 Mbit		
RAM (DDR3)	512 MB					
ROM (RAW NAND)	512 MB					
MAC table	16K					
VLAN table	4K					
L2 Multicast groups	2K					
ARP table ¹	1K					
Link Aggregation Groups (LAG)	16, up to 8 ports per LAG					
Maximum size of ECMP groups	8					
Quality of Services (QoS)	8 egress queues per port					

TCAM For routing: 1024xIPv4
For traffic processing: 1024x24B

¹For each host in the ARP table, an entry is created in the routing table

Technical features

	MES2324	MES2324B	MES2324F	MES2324FB	MES2326	MES2348B
Jumbo frames size	10240 bytes					
Stacking	8 devices					

Features and capabilities

Interface functions

- Head-of-line blocking (HOL) protection
- Back pressure
- Auto MDI/MDIX
- Jumbo frames
- Flow control (IEEE 802.3X)
- Port mirroring
- Stacking

MAC table functions

- Independent learning mode per VLAN
- MAC Multicast Support
- Configurable aging time of MAC addresses
- Static MAC Entries
- MAC Flapping logging

VLAN functions

- Voice VLAN
- 802.1Q
- Q-in-Q
- Selective Q-in-Q
- GVRP

L2 Multicast functions

- Multicast profiles
- Static Multicast groups
- IGMP Snooping v1,2,3
- Port/host-based IGMP Snooping Fast Leave
- IGMP authorization via RADIUS
- MLD Snooping v1,2
- IGMP Querier
- MVR

L2 functions

- STP (Spanning Tree Protocol, IEEE 802.1d)
- RSTP (Rapid Spanning Tree protocol, IEEE 802.1w)
- MSTP (Multiple Spanning Tree, IEEE802.1s)
- STP Multiprocess
- PVSTP+
- Spanning Tree Fast Link option
- EAPS¹
- STP Root Guard
- STP Loop Guard
- BPDU Filtering
- STP BPDU Guard
- VLAN-based Loopback Detection (LBD)
- ERPS (G.8032v2)
- Private VLAN
- Layer 2 Protocol Tunneling

L3 functions

- Static IP routes
- Dynamic routing protocols RIPv2, OSPFv2, OSPFv3
- Address Resolution Protocol (ARP)
- VRRP
- PIM SM, PIM DM, IGMP Proxy
- IP Unnumbered
- ECMP Load Balancing

Link Aggregation functions

- Static LAG
- Dynamic LAG (LACP)
- LAG Balancing Algorithm

IPv6 functions

- IPv6 Host
- Dual-stack

Service functions

- Virtual Cable Testing (VCT)
- Optical transceiver diagnostics
- Green Ethernet

Security functions

- DHCP Snooping
- DHCP Option 82
- IP Source Guard
- Dynamic ARP Inspection
- sFlow
- MAC-based authentication, Port Security, Static MAC entries
- Port-based authentication IEEE 802.1x
- Guest VLAN¹
- DoS attack prevention
- Traffic segmentation
- Protection against non-authorized DHCP servers
- DHCP clients filtering
- BPDU attacks prevention
- NetBIOS/NetBEUI filtering
- PPPoE Intermediate Agent

ACL (Access Control List)

- L2-L3-L4 ACL
- Time-Based ACL
- IPv6 ACL
- ACL based on:
 - Physical port number
 - IEEE 802.1p
 - VLAN ID
 - EtherType
 - DSCP
 - Protocol type
 - TCP/UDP port number
 - User Defined Bytes

¹ Not supported in the current firmware version 4.0.10.1

Features and capabilities

Quality of Service (QoS) and rate limiting

- QoS statistics
- Shaping, Policing
- IEEE 802.1p Class of Service (CoS)
- Storm Control
- Bandwidth management
- Scheduling algorithms: Strict Priority/Weighted Round Robin (WRR)
- Three marking colors
- ACL-based CoS/DSCP mark assignment
- Setting the IEEE 802.1p priority for management VLAN
- DSCP to CoS/CoS to DSCP remarking
- ACL-based VLAN assignment
- 802.1p, DSCP mark assignment for IGMP

OAM/CFM

- 802.3ah Ethernet Link OAM
- Dying Gasp
- 802.1ag Connectivity Fault Management (CFM)¹
- 802.3ah Unidirectional Link Detection (UDLD)

Main management functions

- Download and upload of configuration file via TFTP/SCP
- Redirecting the output of CLI commands to an arbitrary file on ROM
- SNMP
- Command Line Interface (CLI)
- Web interface
- Syslog
- SNTP (Simple Network Time Protocol)
- Traceroute
- LLDP (802.1ab) + LLDP MED
- Access control – privilege levels
- Management interface blocking
- Local authentication
- IP addresses filtering for SNMP
- RADIUS, TACACS+ (Terminal Access Controller Access Control System) clients
- SSH server
- SSL
- Macrocommands
- CLI commands logging
- System log
- DHCP autoprovision
- DHCP Relay (IPv4 support)
- DHCP Option 12
- DHCP Relay Option 82
- PPPoE Circuit-ID tag
- Flash File System
- Debugging commands
- Rate limit of traffic to CPU
- Password encryption
- Password recovery
- Ping (IPv4/IPv6 support)
- FTP server¹
- DNS server

Monitoring functions

- Statistics on interfaces
- RMON/SMON
- CPU utilization monitoring per task and per traffic type
- RAM utilization monitoring
- Temperature monitoring
- TCAM utilization monitoring

MIB

- RFC 1065, 1066, 1155, 1156, 2578 MIB Structure
- RFC 1212 Concise MIB Definitions
- RFC 1213 MIB II
- RFC 1215 MIB Traps Convention
- RFC 1493, 4188 Bridge MIB
- RFC 1157, 2571-2576 SNMP MIB
- RFC 1901-1908, 3418, 3636, 1442, 2578 SNMPv2 MIB
- RFC 271,1757, 2819 RMON MIB
- RFC 2465 IPv6 MIB
- RFC 2466 ICMPv6 MIB
- RFC 2737 Entity MIB
- RFC 4293 IPv6 SNMP Mgmt Interface MIB
- Private MIB
- RFC 3289 DIFFSERV MIB
- RFC 2021 RMONv2 MIB
- RFC 1398, 1643, 1650, 2358, 2665, 3635 Ether-like MIB
- RFC 2668 802.3 MAU MIB
- RFC 2674, 4363 802.1p MIB
- RFC 2233, 2863 IF MIB
- RFC 2618 RADIUS Authentication Client MIB
- RFC 4022 MIB for TCP
- RFC 4113 MIB for UDP
- RFC 3298 MIB for Diffserv
- RFC 2620 RADIUS Accounting Client MIB
- RFC 2925 Ping & Traceroute MIB
- RFC 768 UDP
- RFC 791 IP
- RFC 792 ICMPv4
- RFC 2463, 4443 ICMPv6
- RFC 4884 Extended ICMP for Multi-Part messages support
- RFC 793 TCP
- RFC 2474, 3260 DS field definition in IPv4 and IPv6 headers
- RFC 1321, 2284, 2865, 3580, 3748 Extensible Authentication Protocol (EAP)
- RFC 2571, RFC2572, RFC2573, RFC2574 SNMP
- RFC 826 ARP

¹ Not supported in the current firmware version 4.0.10.1





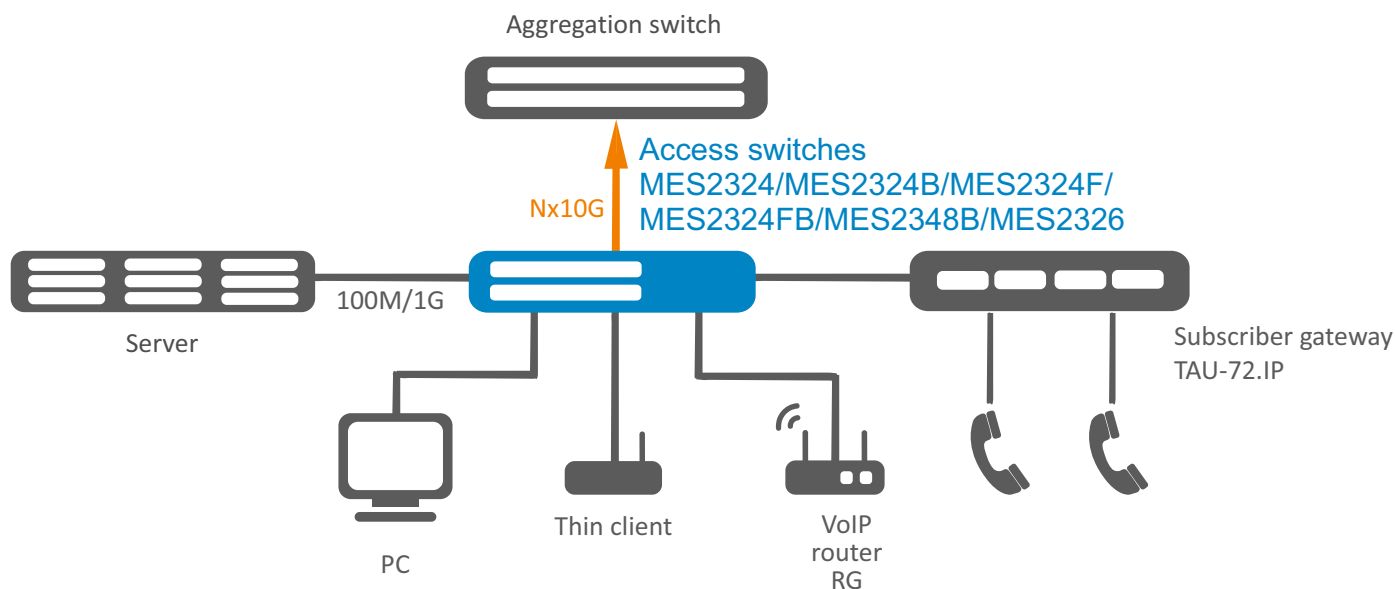

Physical parameters

	MES2324	MES2324B	MES2324F	MES2324FB	MES2326	MES2348B
Physical parameters and parameters of environment						
Maximum power consumption	25 W	50 W	35 W	85 W	25 W	85 W
Power supply	220V AC, 50 Hz; 48V DC	220V AC, 50 Hz	48V DC	220V AC, 50 Hz; 12V DC	220V AC, 50 Hz	
Dying Gasp hardware support	No	No	No	No	Yes	No
Operating temperature	from -20 to +50°C					
Storage temperature	from -40 to +70°C					
Operating humidity	80%					
Cooling	Passive cooling		Active cooling (4 fans)		Passive cooling	Active cooling (4 fans)
Form factor	19", 1U					
Dimensions	430 x 158 x 44	430 x 158 x 44	430 x 243 x 44	430 x 243 x 44	440 x 158 x 44	440 x 280 x 44
Weight	2.25 kg	2.25 kg	3.25 kg	3.55 kg	2.25 kg	3.85 kg

Use Case

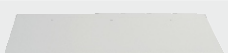

Ordering information

Name	Description	Image
MES2324 AC	MES2324 Ethernet switch, 24 ports of 10/100/1000BASE-T, 4 ports of 10GBASE-R (SFP+)/1000BASE-X (SFP), L2+, 220V AC	
MES2324 DC	MES2324 Ethernet switch, 24 ports of 10/100/1000BASE-T, 4 ports of 10GBASE-R (SFP+)/1000BASE-X (SFP), L2+, 48V DC	
MES2324B	MES2324B Ethernet switch, 24 ports of 10/100/1000BASE-T, 4 ports of 10GBASE-R (SFP+)/1000BASE-X (SFP), L2+, 220V AC, 12V DC	
MES2324F DC	MES2324F Ethernet switch, 20 ports of 1000BASE-X/1000BASE-FX (SFP), 4 ports of 10/100/1000BASE-T/1000BASE-X/100BASE-FX Combo, 4 ports of 10GBASE-R (SFP+)/1000BASE-X (SFP), L2+, 48V DC	
MES2324FB	MES2324FB Ethernet switch, 20 ports of 1000BASE-X/100BASE-FX (SFP), 4 ports of 10/100/1000BASE-T/1000BASE-X/100BASE-FX Combo, 4 ports of 10GBASE-R (SFP+)/1000BASE-X (SFP), L2+, 220V AC, 12V DC	
MES2348B	MES2348 Ethernet switch, 48 ports of 10/100/1000BASE-T, 4 ports of 10GBASE-R (SFP+)/1000BASE-X (SFP), L2+, 220V AC, 12V DC	
MES2326	MES2326 Ethernet switch, 24 ports of 10/100/1000BASE-T, 2 ports of 10/100/1000BASE-T/1000BASE-X/100BASE-FX Combo, 2 ports of 1000BASE-X (SFP), L2+, 220V AC	

Related software

EMS-MES-access	EMS-MES-access option of Eltex.EMS system for managing and monitoring of Eltex network elements: 1 access switch network element	
----------------	--	--

Contact us

+7 (383) 274 10 01
+7 (383) 274 48 48

eltex@eltex-co.ru

www.eltex-co.ru

About Eltex

Eltex company is a leading Russian developer and manufacturer of telecommunication equipment with 25 years of history. Integrity of solutions and seamless integration capability into Customer infrastructure is a priority area of company development.